

Fabric banner “DekoTexx”

How to create your print file



File settings

Format:	final format or scaled (e.g. 1:2)
Resolution:	ratio 1:1 96-150 dpi ratio 1:2 192-300 dpi ratio 1:10 960-1500 dpi
Bleed:	no
Crop marks:	no
Overprint:	deactivated
Fonts:	embedded or converted to paths
Do not use:	clipping paths, alpha channels, masks



File formats

Digital- and large format printing:

- PDF X-3*, TIFF, JPG, PSD (flattened to background layer), EPS*, AI*

*important notice

The file formats can be created with different programs with various attributes. That can cause numerous errors, e.g. deviation of colours, missing or incorrect fonts, missing elements etc.

To avoid such problems please create your data as a ready to print file in PDF / X-3:2002. To prevent incorrect printing, please feel free to send or upload your original file's preview (JPG) for comparison.



Colors

Color mode: CMYK
Color profile: ISO Coated v2, Coated Fogra 27 / 39

Do not use: RGB and spot colors such as Pantone, HKS and RAL. They will be converted / simulated to CMYK. We cannot guarantee for color differences caused by conversion.

Proof

It is not possible to do color adjustments in the RIP software or at the printer. If color accuracy has high priority, we recommend you a proof beforehand.

The file can be created with several different versions of the color (e.g. small squares with the corresponding CMYK values).

We produce a colorbinding proof on the original material with the original colors. If necessary, you have the opportunity to adjust your file before print.

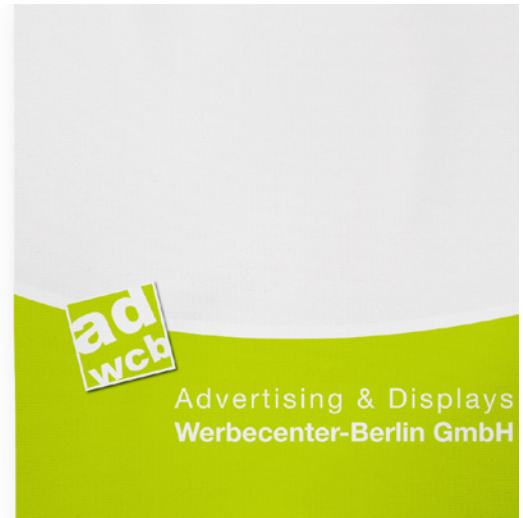

Notes

- We print and produce with a tolerance up to 0,25%, so the size could differ.
- We could not guarantee precisely sizes by millimeter.
- According to the file format, color anomalies may occur.

File upload



upload to our server

Please register in our onlineshop: www.werbecenter-onlineshop.de
When you finished the ordering process, you can upload your artwork directly in our upload-center.



e-mail

daten@werbecenter-berlin.de



by mail

Advertising & Displays
Werbecenter-Berlin GmbH
Zitadellenweg 34
D-13599 Berlin
Germany

Fabric banner “DekoTexx”

How to create your print file

Cut without eyelets

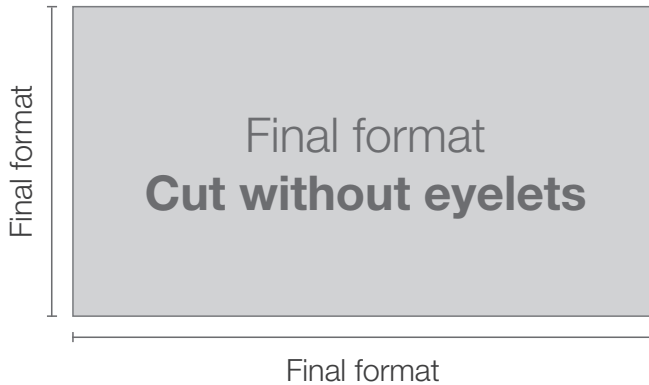

Please order the banner in the final format.
Please create the data without trim, bleed or cropmarks.

With hem and eyelets

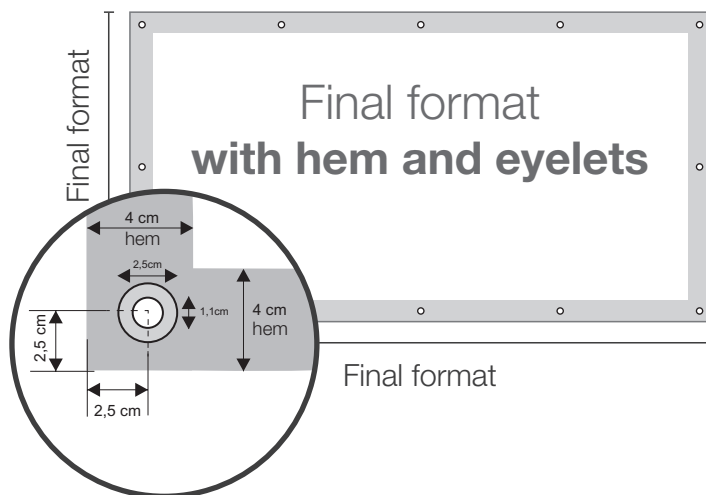

Note

Don't put **important elements such as text, type or logos** in the area the eyelets will be placed (4cm from all sides).

Eyelets will be placed app. every 50 cm – the distance between the eyelets will vary depending on the size of your banner. Therefore we strongly recommend not to install the mounting before the banner has been delivered.

Please order the banner in the final format.
Please create the data without trim, bleed or cropmarks.

- We recommend a safety space of 4 cm for text, logos or other important elements. This area will be used for the eyelets. (4 cm from all sides)

Special manufacturing

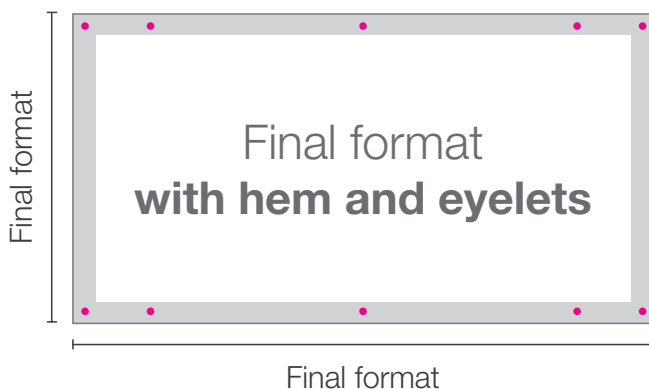

Special placing for the eyelets

If you order a different manufacturing, the standard manufacturing is not applicable.

Please feel free to put marks for the eyelets at the exact position of your printing file.

If your motif is magenta or red, you can also use cyan *100%

- We recommend a safety space of 4 cm for text, logos or other important elements. This area will be used for the eyelets. (4 cm from all sides)

Diameter: 0,5 cm

Color: 100% Magenta*

Fabric banner “DekoTexx”

hemstitch (for example: above, other sides only cut)

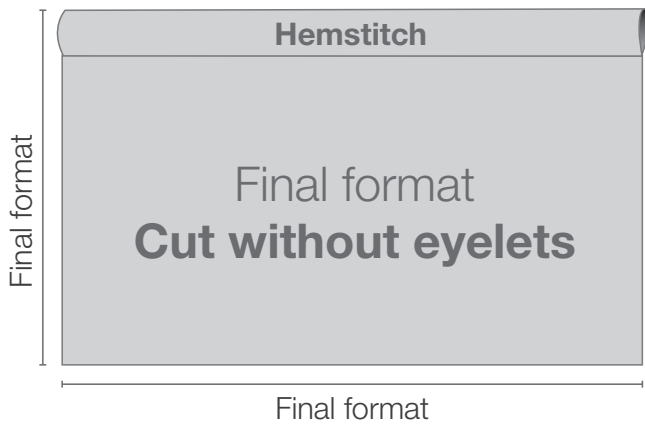

Hemstitch:

Please enter the desired diameter of the hemstitch directly in the ordering process.

**Please order the banner in the final format.
Please create the data without trim, bleed or cropmarks.**

Printing width

We are able to print a width of 300 cm and a height of 5.000 cm (50 m) in one part without partition.

If the shortest side exceeds a measurement of 300 cm the vinyl banner will be produced in several parts and weld together to one banner.

Example 1

The height of the banner is 240 cm and the length is 1.000 cm (10 m).

You will get the banner in one piece.

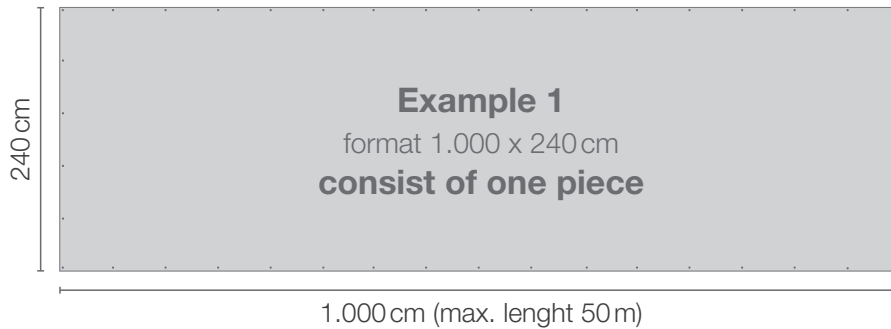

Example 2

The high of the banner is 500 cm and the length is 1.000 cm (10 m).

In this case your banner will be seperated in 5 pieces and sewn together.

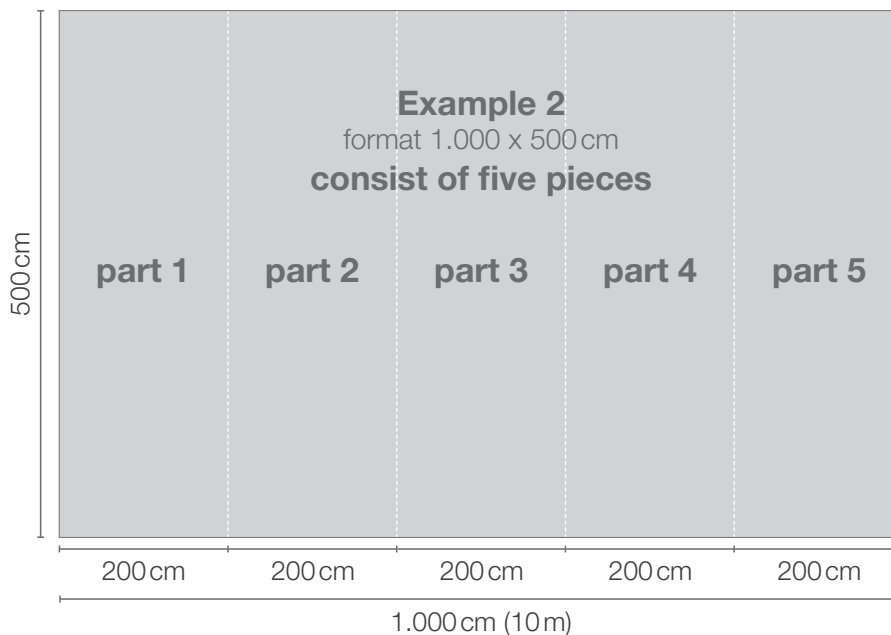



IMPORTANT: Please create the data without trim, bleed or cropmarks.

Fabric banner “DekoTexx”

Note

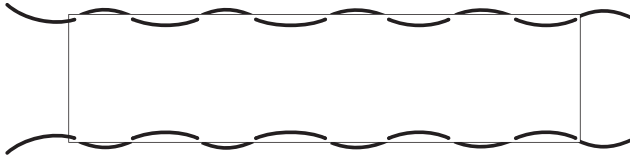
In our shop you can find many accessories and suspension-sets for your banner. If you have any questions please let us know.



 We set your eyelets every 50cm.
Please do not skip any of them - use them!

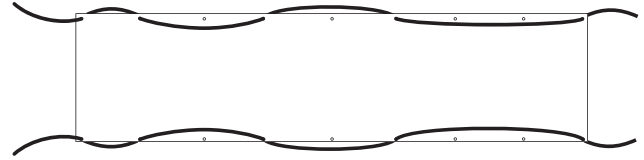

 Please do not skip any grommets.
We couldn't spare any effort if grommets aren't set every 50cm.

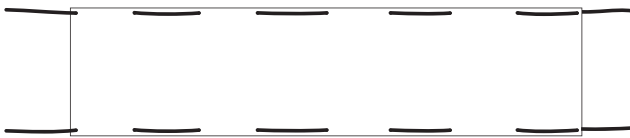

 You get an equal weight distribution if you use all eyelets.

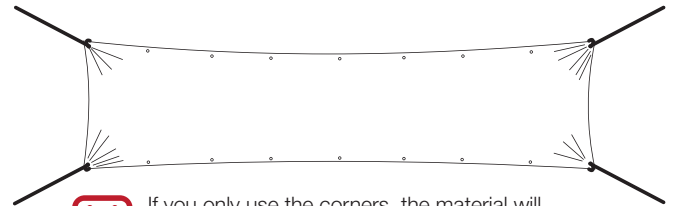

 If you only use the corners, the material will succumb and the grommets tear out because of its weight. You haven't any warranty in this case.



 Wrong!
A banner wich is across a street, over a sidewalk, between two street lights or between trees or the like will be exposed to wind permanently, what causes the tear out of the grommets. Our advice: use mesh banners, no traditional dekotexx banners for outdoor advertising.

DURABILITY

Durability: on average 6-12 month. The endurance depends on the solar radiation and and the place of installation.